

Video-inserter RL2-MZD

Compatible with
MAZDA vehicles
with MZD Connect infotainment and 7inch monitor



example

Video-inserter for rear-view camera and two additional video sources

Product features

- Video-inserter for factory-infotainment systems
- 2 CVBS video-inputs for after-market devices (e.g. USB-player, DVB-T2 tuner)
- Rear-view camera CVBS video-input
- Automatic switching to rear-view camera input on engagement of the reverse gear
- Video-in-motion (ONLY for connected video-sources)
- Video-inputs NTSC compatible

Contents

1. Prior to installation

- 1.1. Delivery contents
- 1.2. Checking the compatibility of vehicle and accessories
- 1.3. Boxes and connectors
 - 1.3.1. Video-Interface
 - 1.3.2. Dip-switch settings – interface
 - 1.3.2.1. Enabling the interface's video inputs (dip 2-3)
 - 1.3.2.2. Rear-view camera setting (dip 5)

2. Installation

- 2.1. Place of installation
- 2.2. Connection schema
- 2.3. Connection - video-interface and Power/CAN
- 2.4. Connection – picture signal cable
- 2.5. Connection – Filter and fuse box
- 2.6. Connection – video sources
- 2.7. After-market rear-view camera
- 2.8. Connection – video interface and external keypad
- 2.9. Picture settings

3. Video interface operation

- 3.1. By infotainment button
- 3.2. By external keypad
- 3.3. By white wire of the 6pin cable

4. Specifications

5. FAQ – Trouble Shooting-Interface functions

6. Technical support

Legal Information

By law, watching moving pictures while driving is prohibited, the driver must not be distracted. We do not accept any liability for material damage or personal injury resulting, directly or indirectly, from installation or operation of this product. Apart from using this product in an unmoved vehicle, it should only be used to display fixed menus or rear-view-camera video when the vehicle is moving (for example the MP3 menu for DVD upgrades).

Changes/updates of the vehicle's software can cause malfunctions of the interface. Up to one year after purchase we offer free software-updates for our interfaces. To receive a free update, the interface has to be sent in at own cost. Wages for de-and reinstallation and other expenditures involved with the software-updates will not be refunded.

No liability for vehicle wire colours and pin definition!

Changes by the vehicle manufacturer are possible. The given information has to be verified by the installer.

1. Prior to installation

Read the manual prior to installation. Technical knowledge is necessary for installation. The place of installation must be free of moisture and away from heat sources.

1.1. Delivery contents

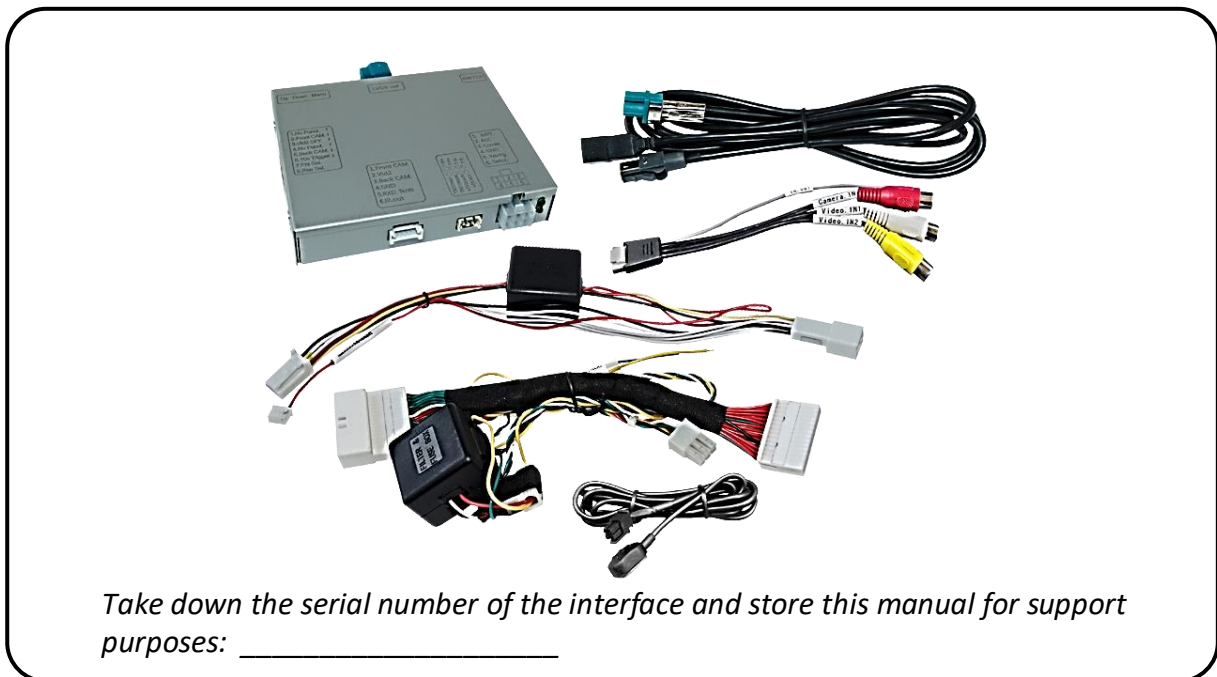

1.2. Checking the compatibility of vehicle and accessories

Requirements		
Brand	Compatible vehicles	Compatible systems
Mazda	2,3,5,6,8 Biante CX-5 CX-9 MX-5	MZD Connect infotainment with 7inch monitor

Limitations:

Video only The interface inserts ONLY video signals into the infotainment. For inserting Audio signals either the possibly existing factory audio-AUX-input or a FM-modulator can be used. If 2 audio sources shall be connected to the infotainment, an additional electronic is necessary to switch them.

Factory rear-view camera Automatically switching-back from inserted video to factory rear-view camera is only possible while the reverse gear is engaged. To delay the switch-back an additional electronic part is required.

Video input signal NTSC video sources compatible only.

1.3. Boxes and connectors

1.3.1. Video Interface

The video-interface converts the video signals of connected after-market sources in a factory monitor compatible picture signal which is inserted in the factory monitor, by using separate trigger options. Further it reads the vehicle's digital signals out of the vehicle's CAN-bus and converts them for the video interface.

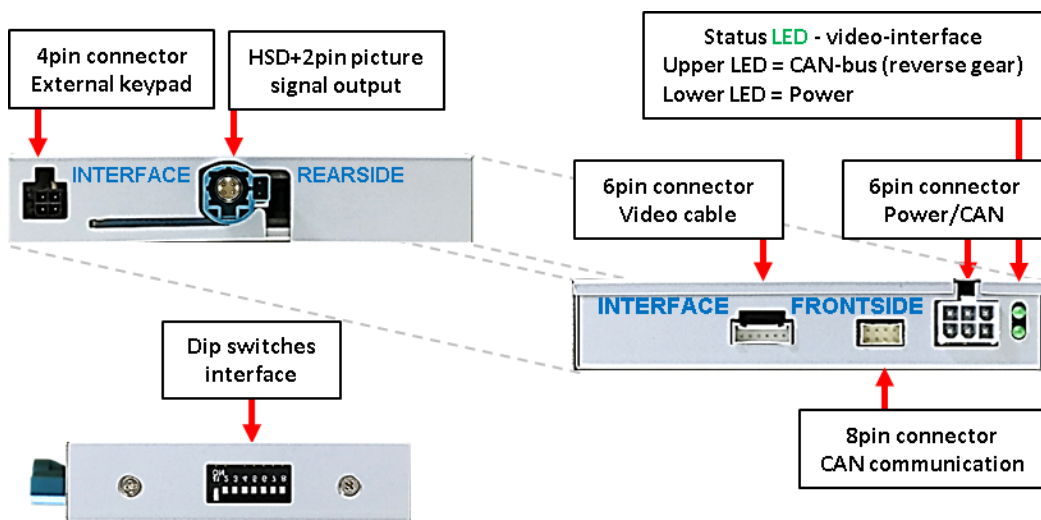

1.3.2. Dip-switch settings – interface

Some settings have to be selected by the dip-switches on the video interface. Dip position down is ON and position up is OFF.



Dip	Function	ON (down)	OFF (up)
1	No function		set to OFF
2	CVBS AV1-input	enabled	disabled
3	CVBS AV2-input	enabled	disabled
4	No function		set to OFF
5	Rear-view cam type	after-market	factory or none
6	No function		set to OFF
7	No function		set to OFF
8	No function		set to OFF

In case of a non-optimal displayed picture with the mentioned dip setting of dip8, we recommend to try the other dip switch position.

After each Dip-switch-change a power-reset of the Can-box has to be performed!

See the following chapters for detailed information.

See the following chapters for detailed information.

1.3.2.1. Enabling the interface's video inputs (dip 2-3)

Only the enabled video inputs can be accessed by switching through the interface's video sources. It is recommended to enable only the required inputs, because the disabled inputs will be skipped while switching through the video interfaces inputs.

1.3.2.2. Rear-view camera setting (dip 5)

If set to **OFF**, the interface switches to factory LVDS picture while the reverse gear is engaged to display factory rear-view camera or factory optical park system picture.

If set to **ON**, the interface switches to its rear-view camera input while the reverse gear is engaged.

Note: Dip 1, 4, 6, 7 and 8 are out of function and have to be set to **OFF**.

2. Installation

To install the interface, first switch off the ignition and disconnect the vehicle's battery. Please read the owner's manual of the car, regarding the battery's disconnection! If required, enable the car's Sleep-mode (hibernation mode)

In case the sleep-mode does not succeed, the disconnection of the battery can be done with a resistor lead.

If the necessary stabilized power supply for the interface is not taken directly from the battery, the chosen connection has to be checked for being constantly stable.

The interface needs a permanent 12V source!

2.1. Place of installation

The interface box is prepared to be connected behind the vehicle's monitor and head-unit. Both parts have to be removed for the installation

2.2. Connection schema

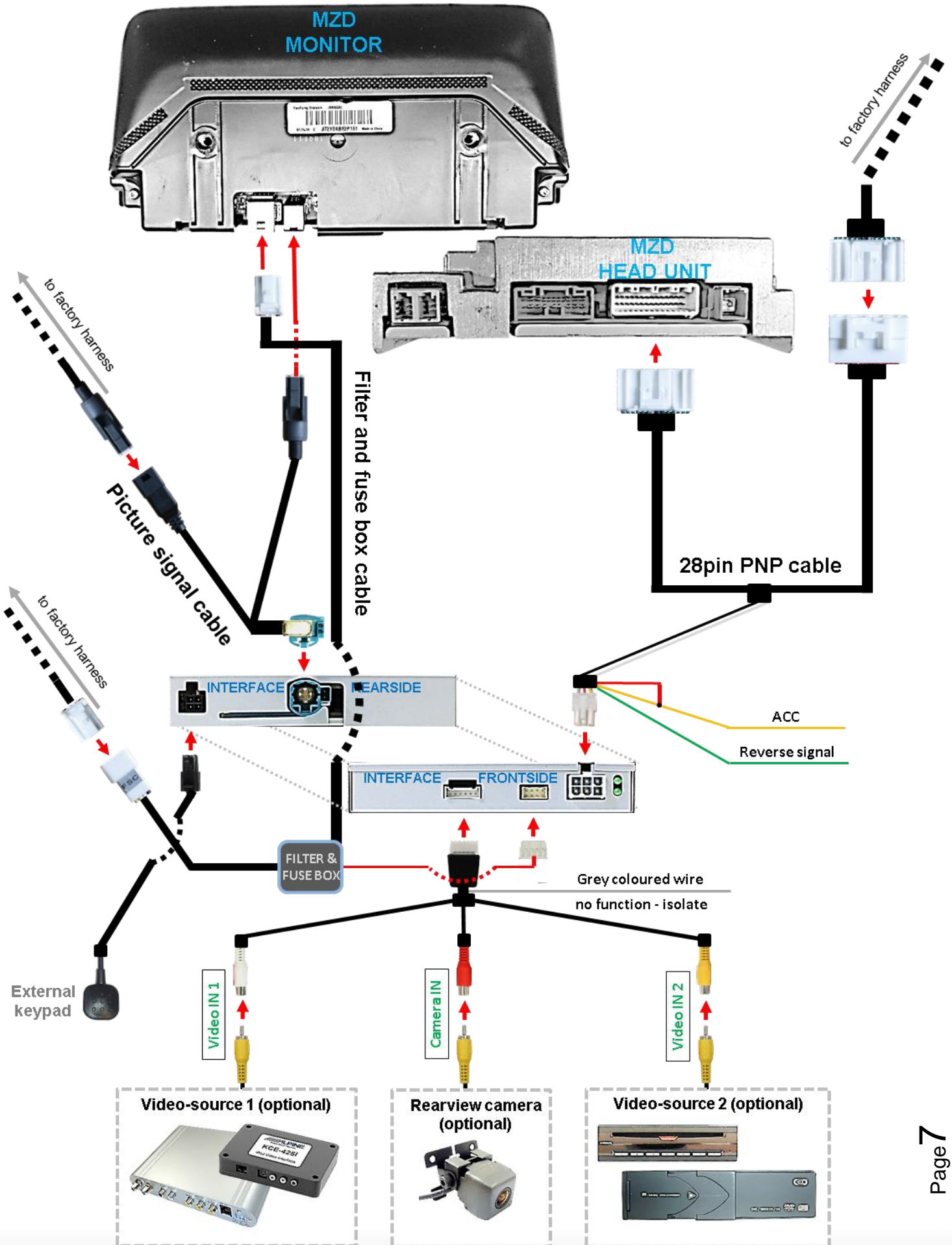

2.3. Connection - video-interface and Power / CAN

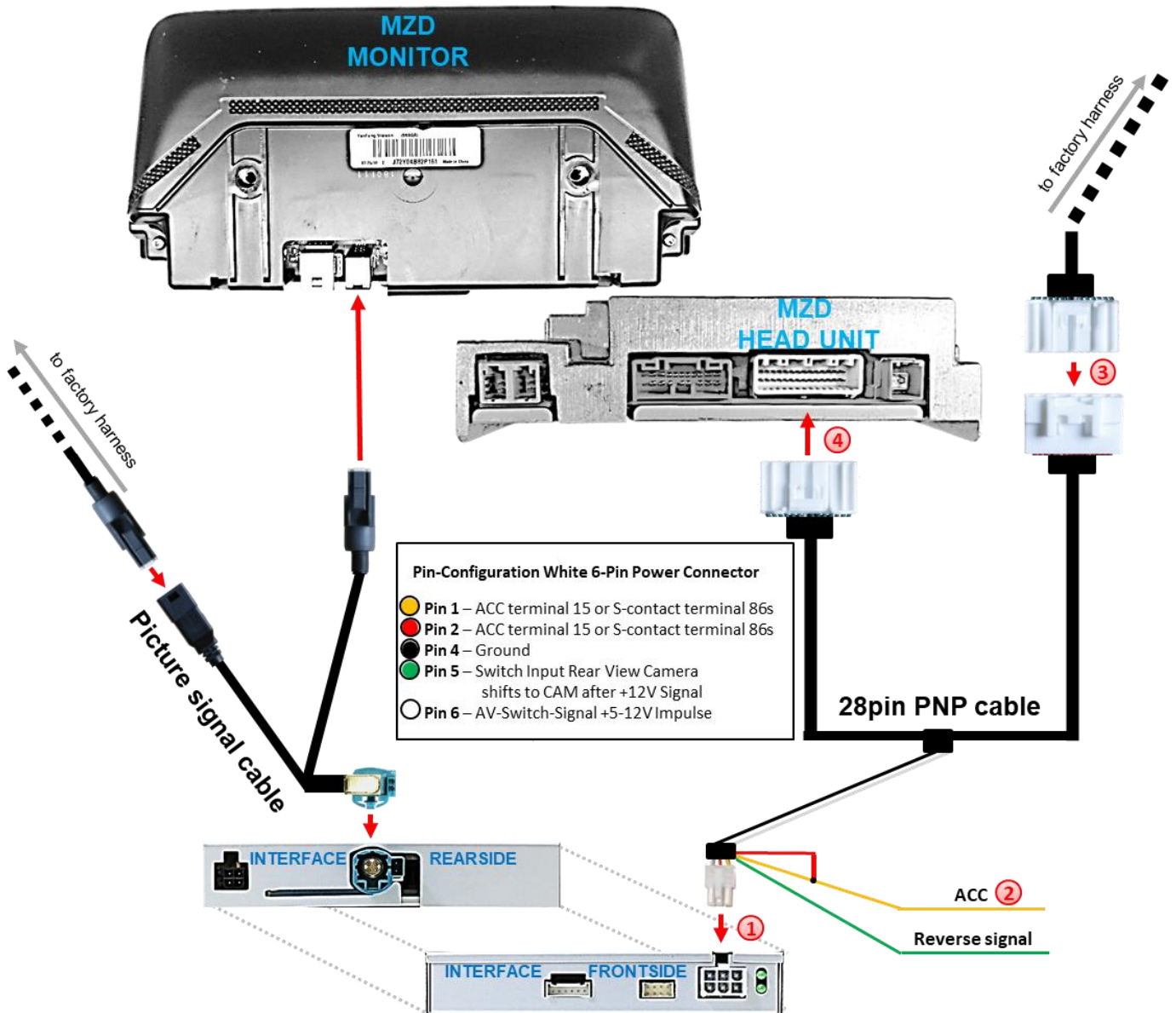

- ① Connect the 6pin cable's white female 6pin pin connector to the male 6pin connector of the video interface.
- ② Connect the 6pin cable's yellow and red coloured wire "TO ACC" to +12V ACC terminal 15 or S-contact terminal 86s. The power consumption is up to 300mA.
- ③ Disconnect the female 28pin connector of the factory harness at the rear-side of the head unit and connect it to the 28pin PNP cable's male 28pin connector.
- ④ Connect the 28pin PNP cable's opposite female 28pin connector to the previously become free male 28pin connector at the rear-side of the head unit.

Check !
Exceptionally, the power supply to the video interfaces may not be interrupted after switching to the vehicle's sleep mode. If the interface LEDs continue to shine even in the vehicle's sleep mode, please contact the support!

2.4. Connection - picture signal cable

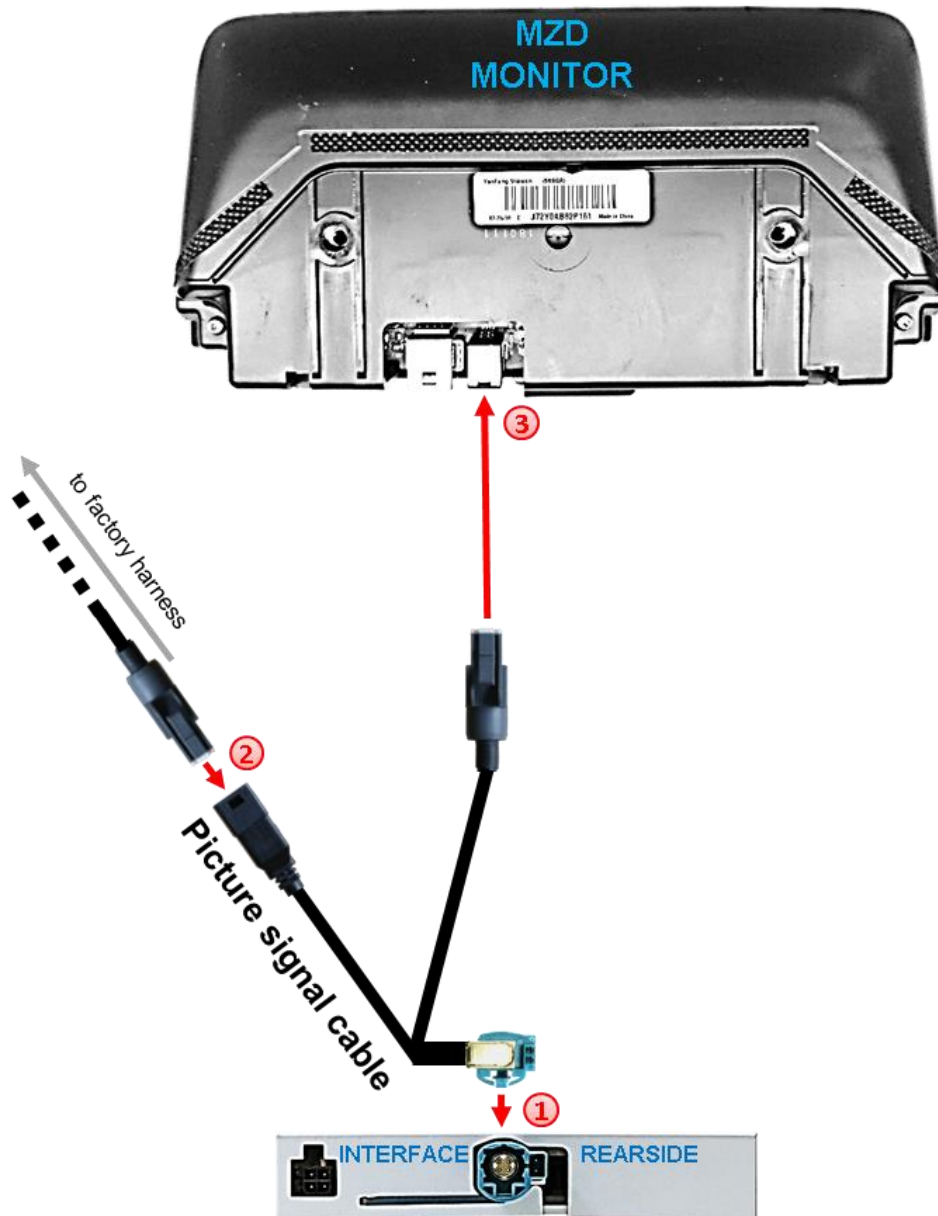

- 1 Connect the enclosed picture signal cable's female waterblue coloured HSD+2 connector to the male waterblue coloured HSD+2 connector of the video interface.
- 2 Disconnect the factory picture signal cable's female 4pin connector at the rear side of the factory monitor and connect it to the black male 4pin connector of the enclosed picture signal cable.
- 3 Connect the picture signal cable's darkgrey coloured female 4pin connector to the previously become free male 4pin connector at the rear side of the factory monitor.

2.5. Connection – Filter and fuse box

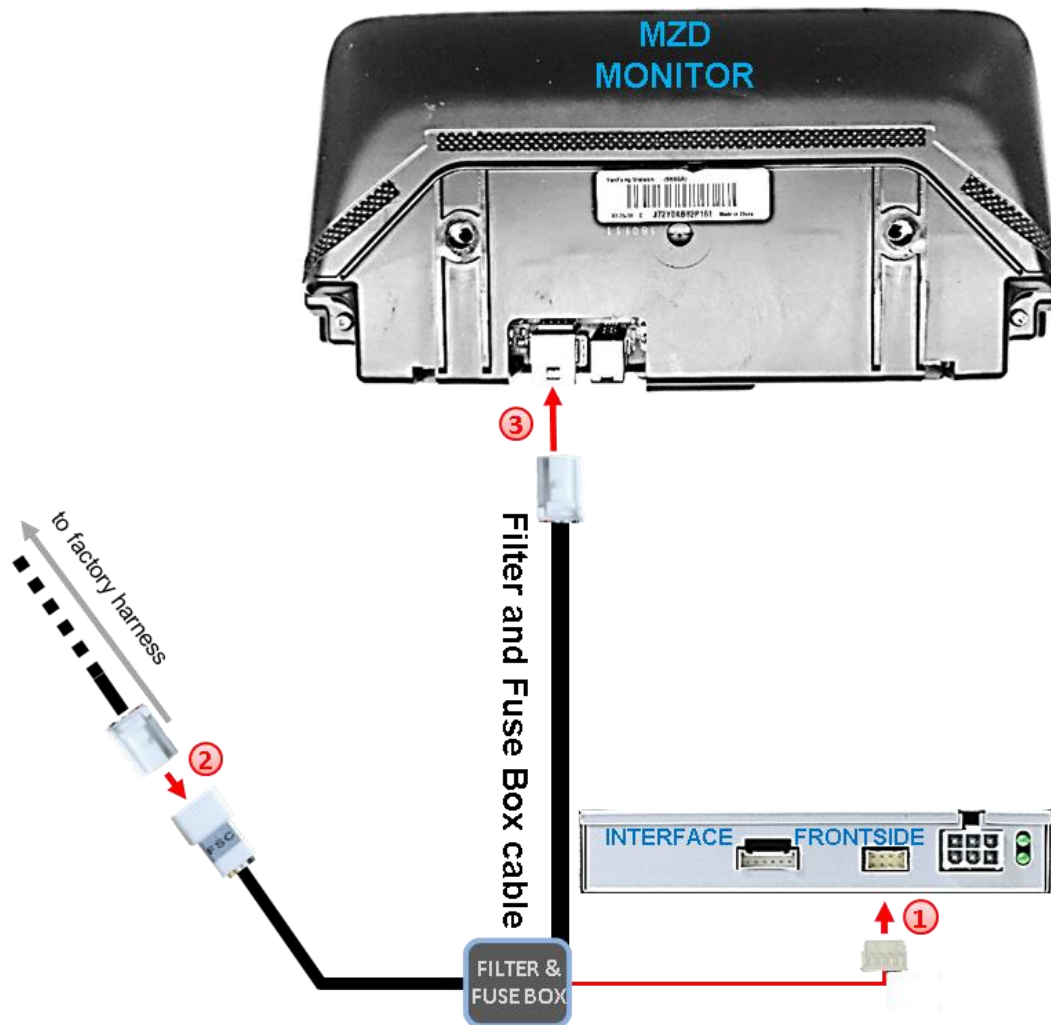

- 1 Connect the filter and fuse box cable's small female 8pin connector to the male 8pin connector of the video interface.
- 2 Disconnect the factory cable's female 8pin connector at the rear-side of the factory monitor and connect it to the filter and fuse box cable's male 8pin connector.
- 3 Connect the filter and fuse box cable's opposite female 8pin connector to the previously become free male 8pin connector at the rear-side of the factory monitor.

2.6. Connection - Video-sources

It is possible to connect two after-market video sources and one after-market rear-view camera to the video-interface.

Before final installation of the peripheral devices, we recommend a test-run to detect a incompatibility of vehicle and interface. Due to changes in the production of the vehicle manufacturer there's always a possibility of incompatibility.

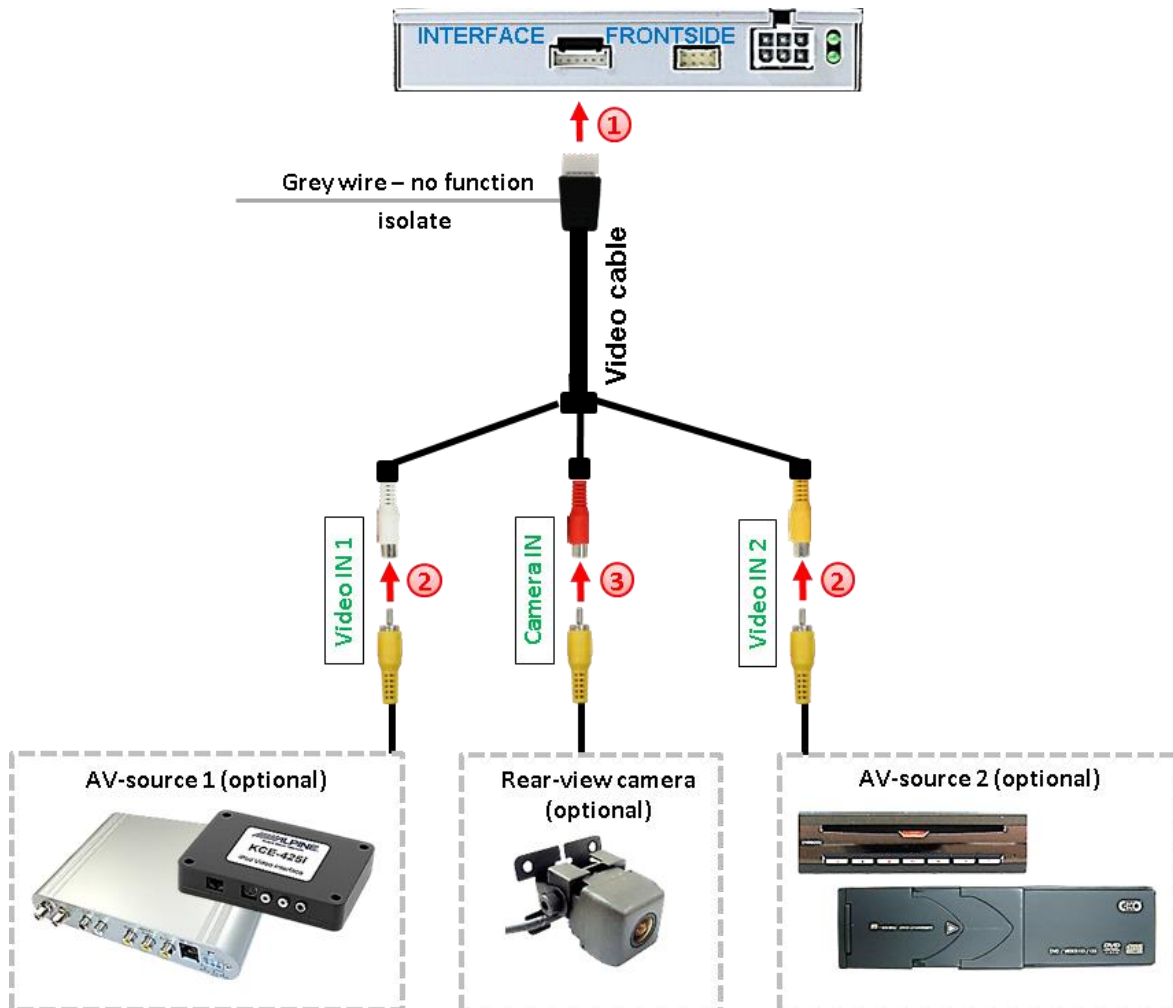

- ① Connect the video cable's female 6pin connector to the video interface's male 6pin connector.
- ② Connect the RCA of the video source 1 and video source 2 to the video cable's female RCA „Video IN1“ and „Video IN2“.
- ③ Connect the rear-view camera's RCA to the video cable's female RCA „Camera IN“.

2.7. After-market rear-view camera

For the function of the rear-view camera, an external switching signal from the reverse gear light is required. As the reverse gear light signal contains electronic interference, use a traditional open relay (e.g. AC-RW-1230 with wiring AC-RS5) or filter (e.g. AC-PNF-RVC). The schema below shows the use of a relay (normally open).

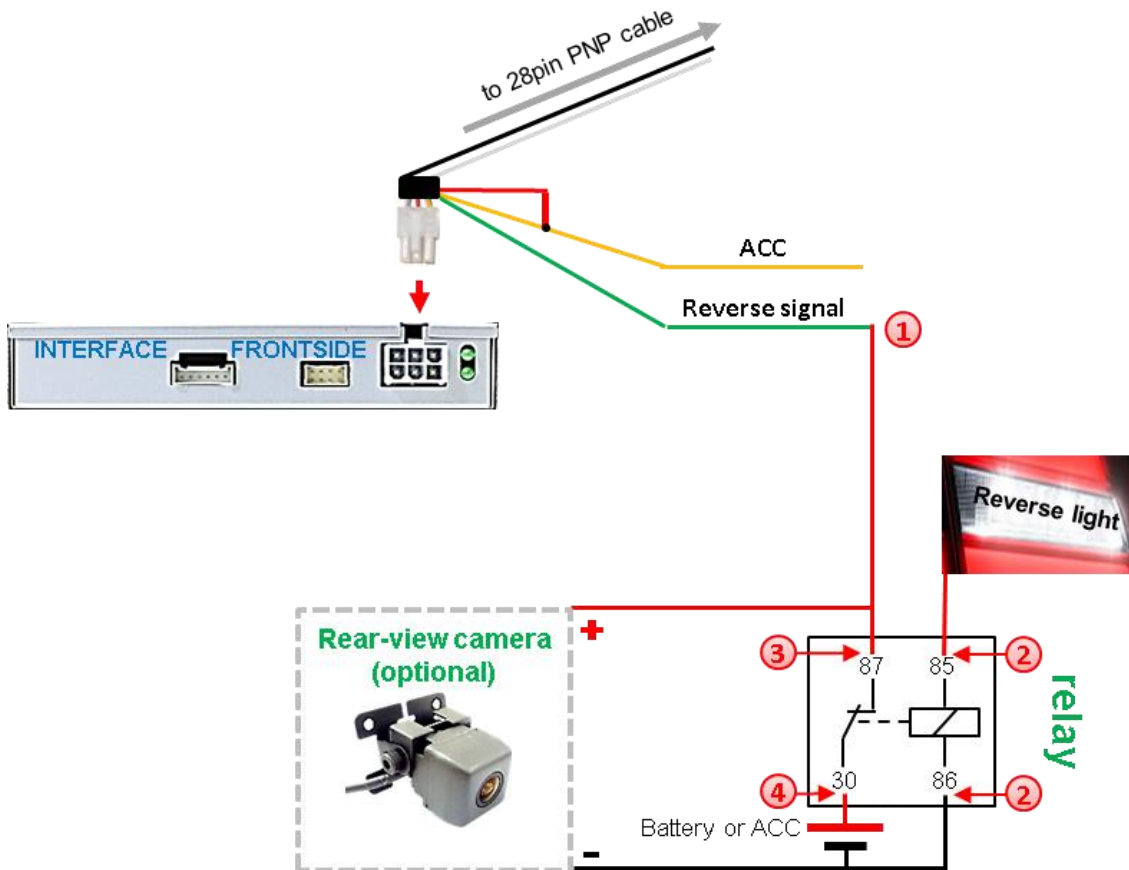

- 1 Connect the 6pin cable's green wire both to output connector (87) of the relay.
- 2 Connect the Reverse light's power-cable to coil (85) and the vehicle's ground to coil (86) of the relay.
- 3 Connect the output connector (87) of the relay to the rear-view camera's power-cable, like you did it to the 6pin cable's green wire before.
- 4 Connect stabile and permanent +12V to the relay's input connector (30).

Note: Set dip5 of video-interface to ON.

2.8. Connection - video-interface and external keypad

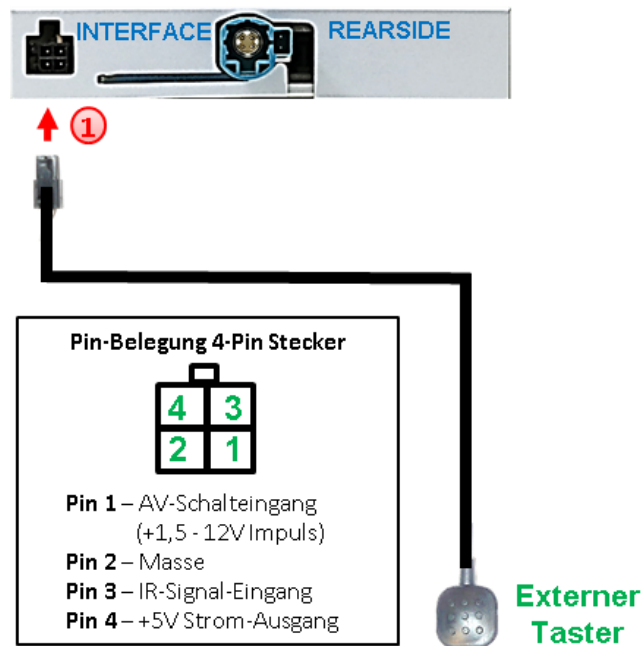

- 1 Connect the keypad's female 4pin connector to the video-interface's male 4pin connector.

Note: Even if the switching through several video sources by the keypad mightn't be required, the invisible connection and availability is strongly recommended.

2.9. Picture settings

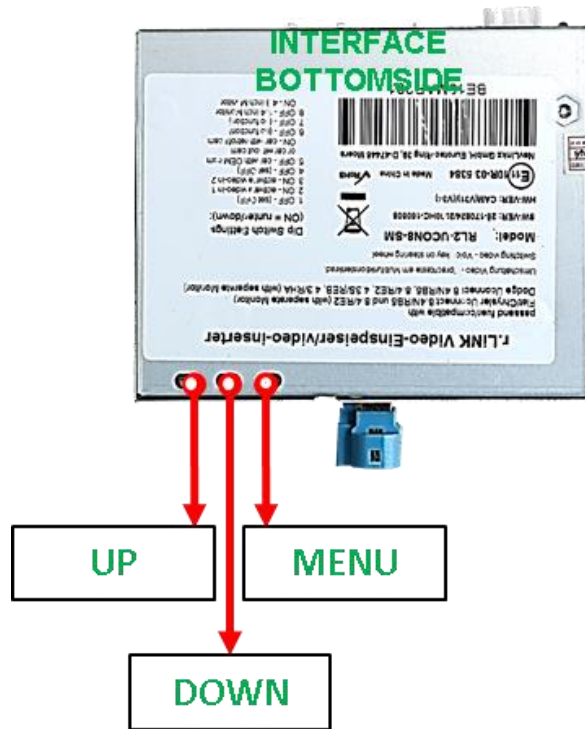

The picture settings are adjustable by the 3 push-buttons on the video-interface. Press the MENU button to open the OSD settings menu or to switch to the next menu item. Press UP and DOWN to change the selected value. The buttons are placed inside in the housing to avoid accidental changes during or after the installation. Picture settings must be done separately for CAM, AV1 and AV2 while the corresponding input is selected and visible on the monitor. AV2 and CAM may share the same settings, then to be adjusted in AV2.

Note: The OSD menu is only shown when a working video source is connected to the selected video-input of the interface.

The following settings are available:

- Contrast
- Brightness
- Saturation
- Position H (horizontal)
- Position V (vertical)
- IR-AV1/2 (no function)
- Guide L/R (no function)
- UI-CNTRL (no function)
- Size H/V (picture size horizontal/vertical)

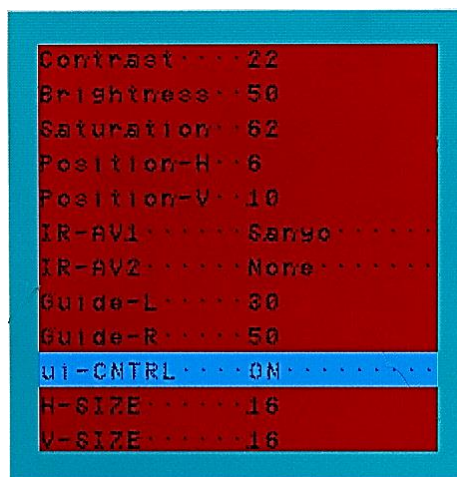

3. Video interface operation

3.1. By infotainment buttons

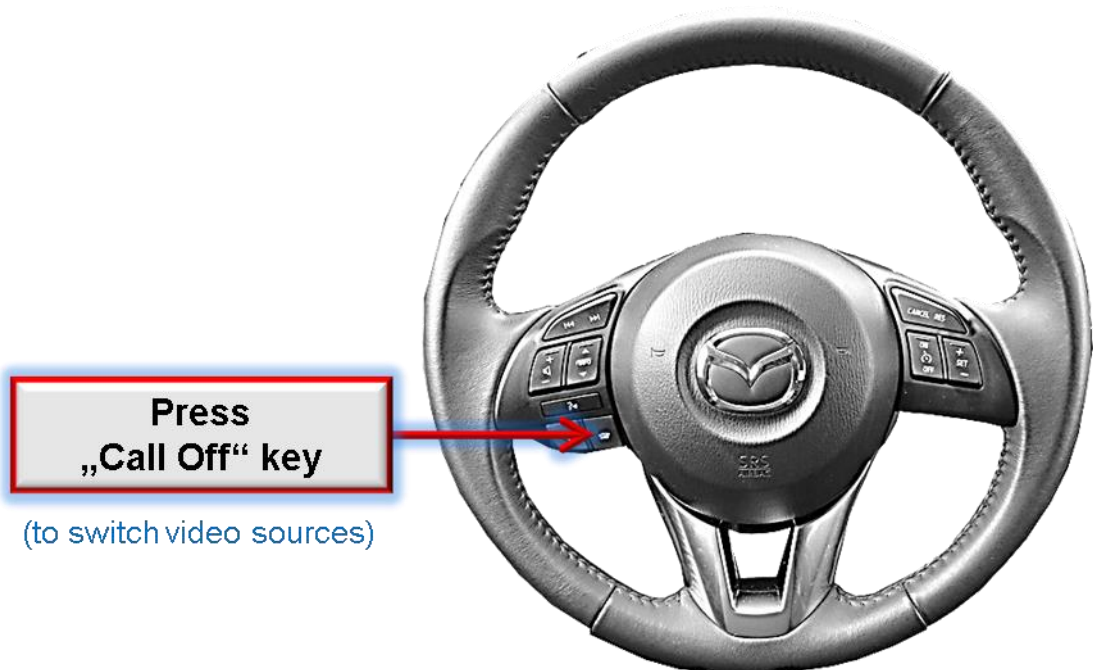

To switch the video sources the vehicle's infotainment button at the steering wheel can be used.

A press of the steering wheel's "Call Off" key switches to the next activated video input.

If all inputs are enabled the order is:

Factory video → video IN1 → video IN2 → factory video →...

Disabled inputs will be skipped.

Switchover by vehicle buttons isn't possible in all vehicles. In some vehicles the external keypad or the white wire of the 6pin to 8pin cable has to be used (see following chapter).

3.2. By external keypad

Alternatively or additionally to the factory infotainment buttons, the interface's external keypad can be used to switch the enabled inputs.

3.3. By white wire of the 6pin cable

Alternatively or additionally to the factory infotainment button, the white wire of the 6pin cable can be used to switch the enabled inputs.

Every +5-12V pulse switches the video interface to the next enabled input.

4. Specifications

BATT/ACC range	7V - 25V
Stand-by power drain	7mA
Power	260mA
Video input	0.7V - 1V
Video input formats	NTSC
RGB-video amplitude	0.7V with 75 Ohm impedance
Temperature range	-40°C to +85°C
Dimensions video-box	112 x 23 x 111 mm (W x H x D)

5. FAQ – Trouble shooting Interface functions

For any troubles which may occur, check the following table for a solution before requesting support from your vendor.

Symptom	Reason	Possible solution
No picture/black picture (factory picture).	Not all connectors have been reconnected to factory head-unit or monitor after installation.	Connect missing connectors.
	No power on CAN-bus box (all LED CAN-bus box are off).	Check power supply of CAN-bus box. Check CAN-bus connection of CAN-bus box.
	CAN-bus box connected to CAN-bus in wrong place.	Refer to the manual where to connected to the CAN-bus. If not mentioned, try another place to connect to the CAN-bus.
	No power on video-interface (all LED video-interface are off).	Check whether CAN-bus box delivers +12V ACC on red wire output of 8pin to 6pin cable. If not cut wire and supply ACC +12V directly to video-interface.
No picture/black picture/white picture (inserted picture) but factory picture is OK.	No picture from video source.	Check on other monitor whether video source is OK.
	No video-source connected to the selected interface input.	Check settings dips 1 to 3 of video interface which inputs are activated and switch to corresponding input(s).
	LVDS cables plugged in wrong place.	Double-check whether order of LVDS cables is exactly connected according to manual. Plugging into head-unit does not work when the manual says to plug into monitor and vice versa.
Inserted picture totally wrong size or position.	Wrong monitor settings of video-interface.	Try different combinations of dips 7 and 8 of video-interface. Unplug 6pin power after each change.
Inserted picture double or 4 times on monitor.		
Inserted picture distorted, flickering or running vertically.	Video sources output set to AUTO or MULTI which causes a conflict with the interfaces auto detection.	Set video source output fixed to PAL or NTSC. It is best to set all video sources to the same standard.
	If error occurs only after source switching: Connected sources are not set to the same TV standard.	Set all video sources to the same standard.
	Some interfaces can only handle NTSC input.	Check manual whether there is a limitation to NTSC mentioned. If yes, set source fixed to NTSC output.
Inserted picture b/w.	Picture settings have not been adjusted.	Use the 3 buttons and the interface's OSD to adjust the picture settings for the corresponding video input.
Inserted picture qual. bad.		
Inserted picture size slightly wrong.		
Inserted picture position wrong.		
Camera input picture flickers.	Camera is being tested under fluorescent light which shines directly into the camera.	Test camera under natural light outside the garage.
Camera input picture is bluish.	Protection sticker not removed from camera lens.	Remove protection sticker from lens.

Symptom	Reason	Possible solution
Camera input picture black.	Camera power taken directly from reverse gear lamp.	Use relay or electronics to "clean" reverse gear lamp power. Alternatively, if CAN-bus box is compatible with the vehicle, camera power can be taken from green wire of 6pin to 8pin cable.
Camera input picture has distortion.		
Camera input picture settings cannot be adjusted.	Camera input picture settings can only be adjusted in AV2 mode.	Set dip 3 of video-interface to ON (if not input AV2 is not already activated) and connect the camera to AV2. Switch to AV2 and adjust settings. Reconnect camera to camera input and deactivate AV2 if not used for other source.
Graphics of a car in camera input picture.	Function PDC is ON in the interface OSD.	In compatible vehicles, the graphics will display the factory PDC distance. If not working or not wanted, set interface OSD menu item UI-CNTRL to ALLOFF.
Chinese signs in camera input picture	Function RET or ALL is ON (function for Asian market) in the interface OSD.	Set interface OSD menu item UI-CNTRL to ALLOFF or PDCON.
Not possible to switch video sources by OEM button.	CAN-bus interface does not support this function for vehicle.	Use external keypad or cut white wire of 6pin to 8pin cable and apply +12V impulses for AV-switching.
Not possible to switch video sources by external keypad.	Pressed too short.	For video source switching a longer press of about 2.5 seconds is required.
	SW-version of interface does not support external keypad.	Use OEM-button or cut white wire of 6pin to 8pin cable and apply +12V impulses for AV-switching.
Interface does not switch to camera input when reverse gear is engaged.	CAN-bus interface does not support this function for the vehicles.	Cut the green wire of the 6pin to 8pin cable and apply +12V constant from reverse gear-lamp signal. Use relay to "clean" R-gear lamp power.
Interface switches video-sources by itself.	CAN-bus interface compatibility to vehicle is limited.	Cut the grey wire of 6pin to 8pin and isolate both ends. If problem still occurs, additionally cut the white wire of 6pin to 8pin cable and isolate both ends.

6. Technical Support

Please note that direct technical support is only available for products purchased directly from NavLinkz GmbH. For products bought from other sources, contact your vendor for technical support.

NavLinkz GmbH
distribution/tech dealer-support
 Heidberghof 2
 D-47495 Rheinberg

Tel +49 2843 17595 00
 Email mail@navlinkz.de

 10R-03 5384

Made in China

